

Features	General Description
----------	---------------------

- ◆ Operating voltage range: 4.5V to 28V
- ◆ Load current limitation
- ◆ Output short-circuit protection
- ◆ Standby current <math><2.0\mu\text{A}</math>
- ◆ On-state resistance $\text{Typ}=46\text{m}\Omega$ (per Ch)
- ◆ Thermal shutdown indication
- ◆ OFF-state open-load detection
- ◆ Overvoltage clamp
- ◆ Undervoltage protection
- ◆ Multiplexed analog feedback of load current with high precision proportional current mirror
- ◆ RoHS compliant and lead free
- ◆ AEC-Q100 qualified

- ◆ WSD7040AF is double channel high-side drivers with current sense analog feedback for automotive applications, the devices are designed to drive 12 V automotive grounded loads through a 3 V and 5 V.
- ◆ WSD7040AF integrates advanced protective functions such as load current limitation, overload active management by power limitation and overtemperature shutdown.
- ◆ A dedicated multifunction multiplexed analog output pin delivers sophisticated diagnostic functions including high precision proportional load current sense, in addition to the detection of overload and short circuit to ground, short to V_{CC} and OFF-state open-load.
- ◆ A sense enable pin allows OFF-state diagnosis to be disabled during the module low power mode as well as external sense resistor sharing among similar devices.
- ◆ WSD7040AF is available in DFN5×6-14L package.

Application

- ◆ All types of automotive resistive, inductive and capacitive loads
- ◆ Specially intended for automotive signal lamps

Typical Application Circuit

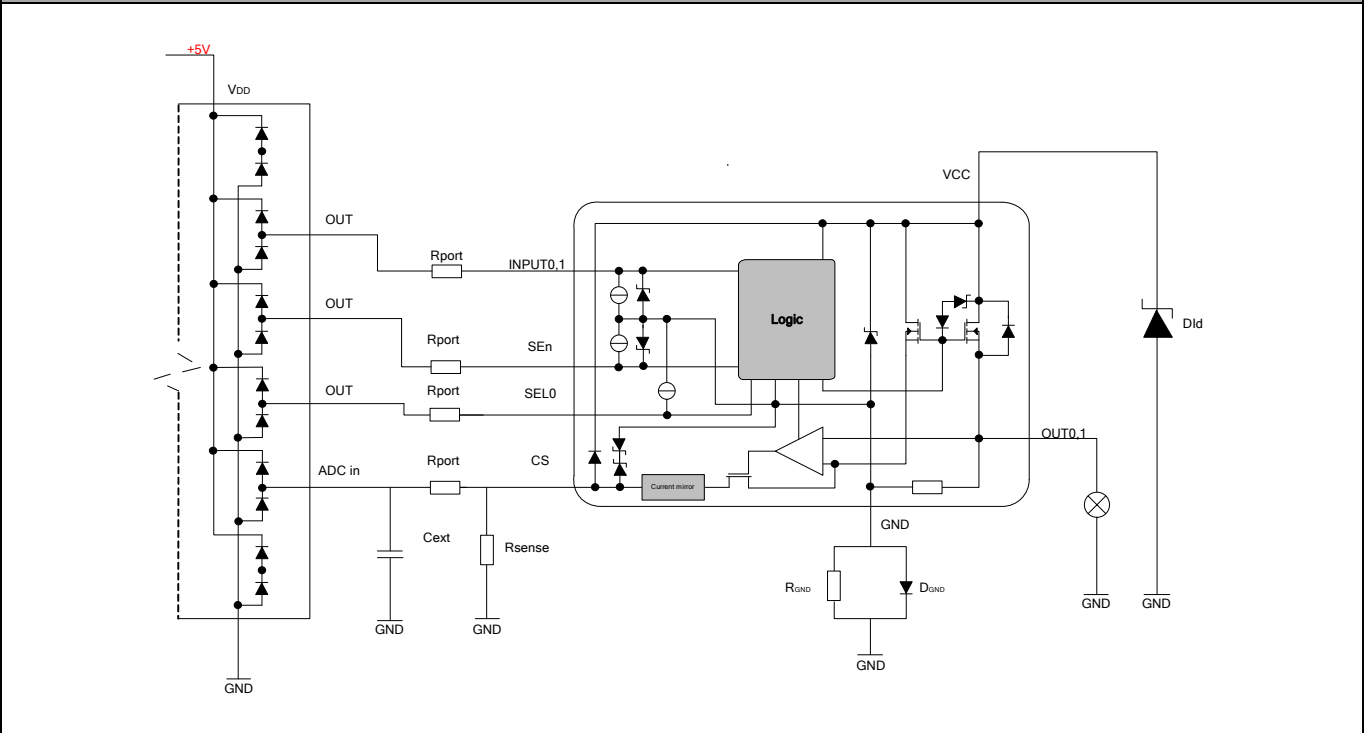

Ordering Information

Package	Top Mark	Part No.
14-Pin DFN5×6-14L, Pb-free	WSD7040AF XXYMXX	WSD7040AF

Pin Configuration

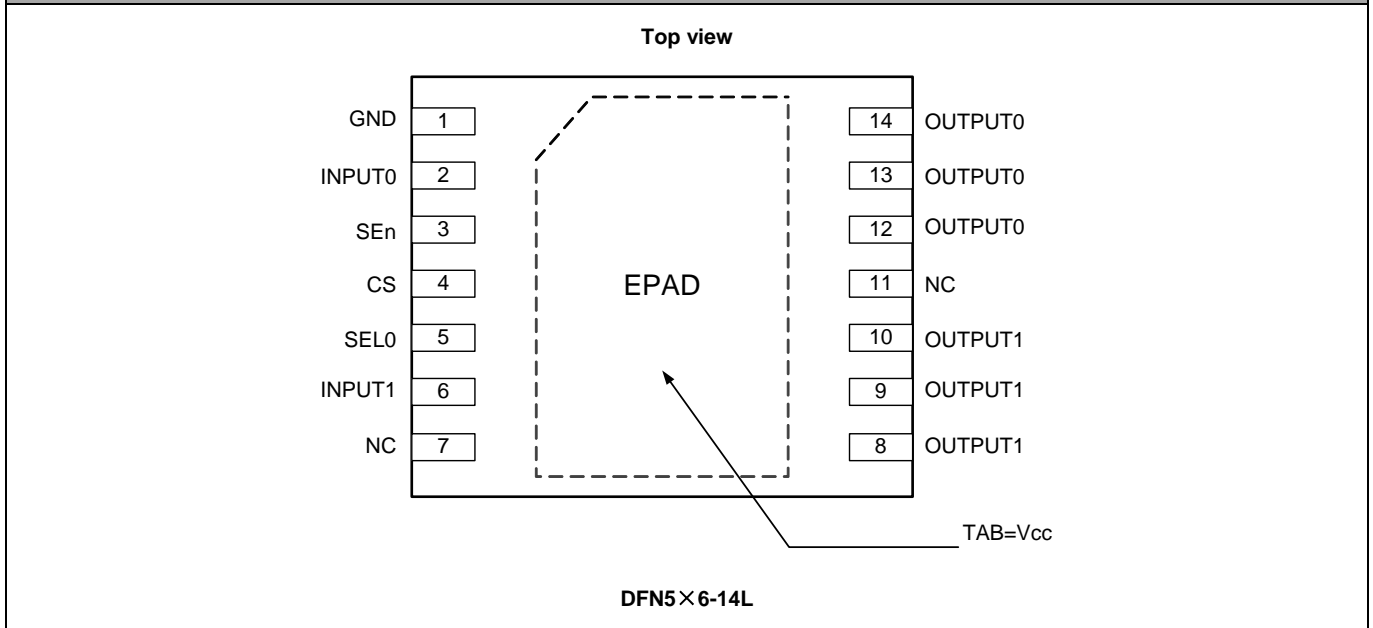

Pin Description

Pin Name	Pin NO.	Pin Description
GND	1	Ground connection. Must be reverse battery protected by an external diode / resistor network.
INPUT0/1	2/6	Voltage controlled input pin with hysteresis, compatible with 3 V and 5 V CMOS outputs. It controls output switch state.
SEn	3	Active high compatible with 3 V and 5 V CMOS outputs pin; it enables the CS diagnostic pin.
CS	4	Multiplexed analog sense output pin; it delivers a current proportional to the load current.
SEL0	5	Active high compatible with 3 V and 5 V CMOS outputs pin; it address the CS multiplexer.
NC	7/11	Not connected.
OUTPUT1	8/9/10	Power outputs.
OUTPUT0	12/13/14	
V _{CC}	EPAD	Battery connection.

Table 1. Suggested connections for unused and not connected pins

Connection / pin	CS	OUTPUT	INPUT	SEn, SEL0
Floating	Not allowed	X ⁽¹⁾	X	X
To ground	Through 1K resistor	Not allowed	Through 15K resistor	Through 15K resistor

Note1: X do not care.

Current and Voltage Conventions

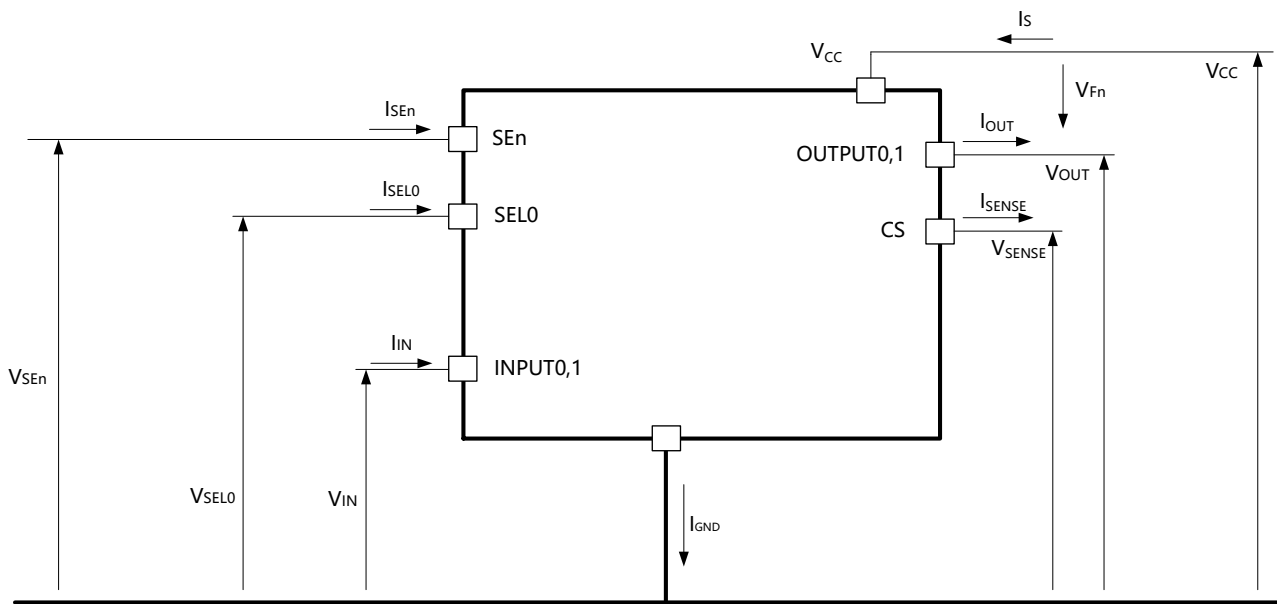

Note2: $V_F = V_{OUT} - V_{CC}$ during reverse battery condition.

Absolute Maximum Ratings (Note3)

Symbol	Parameter	Value	Unit
V_{CC}	DC supply voltage	35	V
$-V_{CC}$	Reverse DC supply voltage	0.3	V
$-I_{GND}$	DC reverse ground pin current	200	mA
I_{OUT}	OUTPUT0,1 DC output current	Internally limited	A
$V_{IN}, V_{SEn}, V_{SEL}, V_{Fault}$	INPUT0,1, SE _n , SEL0,1, Fault DC input voltage	-0.3 to 6.0	V
I_{SENSE}	CS pin DC output current	20	mA
	CS pin DC output current in reverse	-20	
T_j	Junction operating temperature	-40 to 150	°C
T_{stg}	Storage temperature	-55 to 150	

Note3: Stressing the device above the rating listed in Absolute maximum ratings may cause permanent damage to the device. These are stress ratings only and operation of the device at these or any other conditions above those indicated in the operating sections of this specification is not implied.

Exposure to the conditions in table below for extended periods may affect device reliability.

ESD Susceptibility (Note4)

Symbol	Parameter	Values	Unit
$V_{ESD(HBM)}^{3)}$	ESD Susceptibility all Pins (HBM)	±2	kV
$V_{ESD(HBM)_{OUT}}$	ESD Susceptibility OUT vs GND and V_{CC} connected (HBM)	±4	kV
$V_{ESD(CDM)}^{4)}$	ESD Susceptibility all Pins (CDM)	±500	V
$V_{ESD(CDM)_{CRN}}$	ESD Susceptibility Corner Pins (CDM) (pins 1, 8, 9, 16)	±750	V

Note4:

- 1) Not subject to production test - specified by design.
- 2) Maximum digital input voltage to be considered for Latch-Up tests: 5.5 V.
- 3) ESD susceptibility, Human Body Model "HBM", according to AEC Q100-002.
- 4) ESD susceptibility, Charged Device Model "CDM", according to AEC Q100-011.

Thermal Resistance (Note5)

Symbol	Parameter	Value	Unit
T_{JC}	Thermal Resistance Junction-to-Case	1.3	°C/W
T_{JA}	Junction-to-Ambient Thermal Resistance	28	°C/W

Note5: According to JEDEC JESD51-2,-5,-7 at natural convection on FR4 2s2p board; the Product (Chip + Package) was simulated on a 76.2 × 114.3 × 1.5 mm board with 2 inner copper layers (2 × 70 μm Cu, 2 × 35 μm Cu). Where applicable a thermal via array under the exposed pad contacted the first inner copper layer.

Functional Block

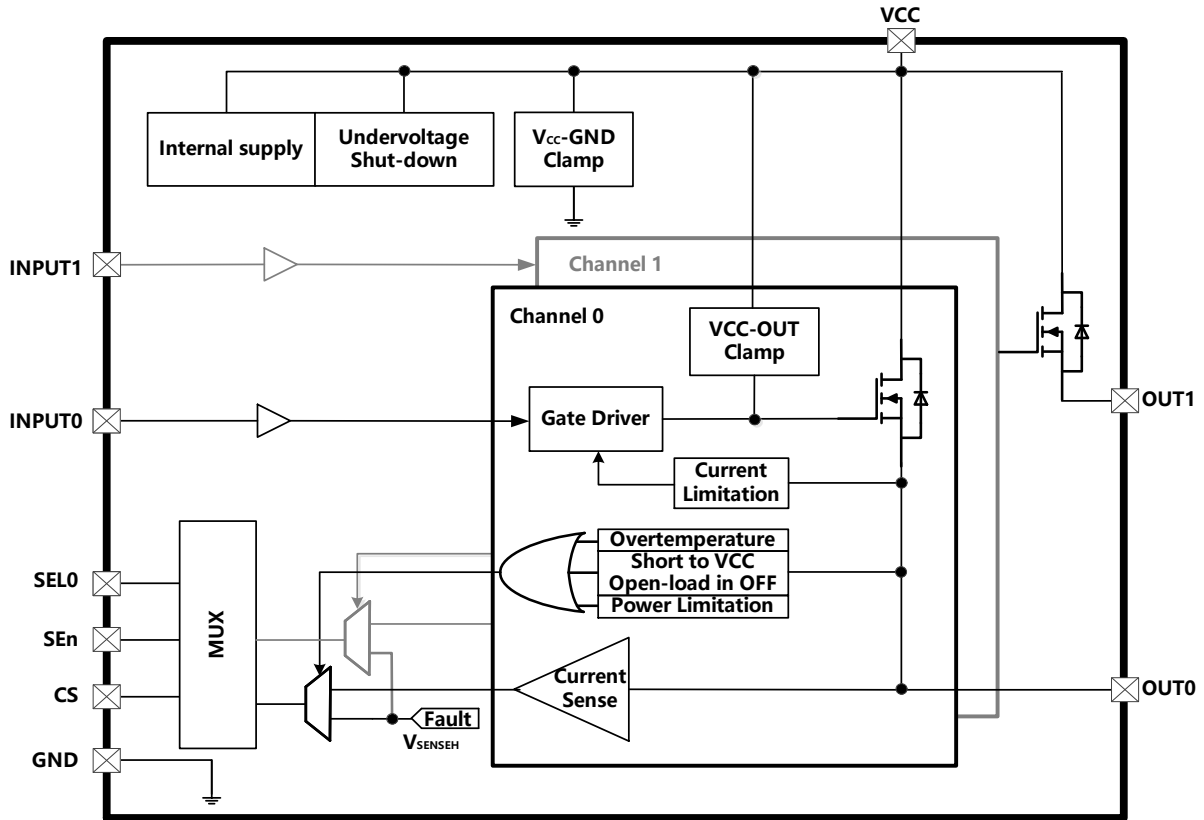

Electrical Characteristics (Note6)

Power section

Parameter	Symbol	Test Condition	Min.	Typ.	Max.	Unit
Operating supply voltage	V_{CC}		4.5	13	28	V
Under voltage shutdown	V_{USD}				4.5	V
Under voltage shutdown reset	$V_{USDReset}$				5	V
Under voltage shutdown hysteresis	$V_{USDhyst}$			0.3		V
On-state resistance	R_{ON}	$I_{OUT}=3A, V_{SEN}=5V, T_j = 25^\circ C$		46		mΩ
		$I_{OUT}=3A, V_{SEN}=5V, T_j = 150^\circ C$			80	
		$I_{OUT}=3A, V_{SEN}=5V, V_{CC}=4.5V, T_j = 25^\circ C$			70	
Nominal load current (One Channel Active)	$I_{L(NOM)1}$	$T_A=25^\circ C$		6		A
Nominal load current at $T_A=85^\circ C$ (One Channel Active)	$I_{L(NOM)1_85}$	$T_A=85^\circ C, T_j < 150^\circ C$		4.5		A
Nominal load current (All Channels Active)	$I_{L(NOM)2}$	$T_A=25^\circ C$		4		A
Nominal load current at $T_A=85^\circ C$ (All Channels Active)	$I_{L(NOM)2_85}$	$T_A=85^\circ C, T_j < 150^\circ C$		3		A
Inverse Current Capability	$I_{L(INV)}$	$V_{CC} < V_{OUT}, V_{IN}=5V, T_A=25^\circ C$		6		A
V_{CC} clamp voltage	V_{clamp}	$I_S=20\text{ mA}, 25^\circ C < T_j < 150^\circ C$	35	42	48	V
		$I_S = 20\text{ mA}, T_j = -40^\circ C$	33			
Supply current in standby at $V_{CC} = 13\text{ V}$	I_{STBY}	$V_{CC} = 13\text{ V}, V_{IN}=V_{OUT}=V_{FR}=V_{SEN}=0\text{ V}$ $V_{SEL0,1} = 0\text{ V}, T_j = 25^\circ C$			1.0	μA
		$V_{CC} = 13\text{ V}, V_{IN}=V_{OUT}=V_{FR}=V_{SEN}=0\text{ V},$ $V_{SEL0,1} = 0\text{ V}, T_j = 125^\circ C$			3.0	μA
Standby mode blanking time	t_{D_STBY}	$V_{CC}=13\text{ V}, V_{IN}=V_{OUT}=V_{FR} = V_{SEL0,1}=0\text{ V}$ $V_{SEN}=5\text{ V to } 0\text{ V}$	100	450	900	us
Supply current	$I_{S(ON)}$	$V_{CC}=13\text{ V}, V_{SEN}=V_{FR} = V_{SEL0,1}=0\text{ V},$ $V_{IN0,1}=5\text{ V}, I_{OUT0,1}=0\text{ A}$		6	12	mA
Control stage current consumption in ON state	$I_{GND(ON)}$	$V_{CC}=13\text{ V}, V_{SEN}=5\text{ V}, V_{FR}=V_{SEL0,1}=0\text{ V}$ $V_{IN0,1}=5\text{ V}, I_{OUT0,1}=1\text{ A}$			12	mA
Off-state output current at $V_{CC} = 13\text{ V}$	$I_{L(off)}$	$V_{IN} = V_{OUT} = 0\text{ V}, V_{CC} = 13\text{ V}, T_j = 25^\circ C$	0	0.05	0.5	μA
		$V_{IN} = V_{OUT} = 0\text{ V}, V_{CC} = 13\text{ V}, T_j = 125^\circ C$	0		3.0	μA
Output - V_{CC} diode voltage at $T_j=150^\circ C$	V_F	$I_{OUT} = -0.2\text{ A}, T_j = 150^\circ C$			0.9	V

Switching/ $V_{CC} = 13\text{ V}, -40^\circ C < T_j < 150^\circ C$, unless otherwise specified

Parameter	Symbol	Test Condition	Min.	Typ.	Max.	Unit
Turn-on delay time at $T_j = 25^\circ C$	$T_{d(on)}$	$V_{CC}=13\text{ V}, V_{SEN}=5\text{ V}, R_L=4.3\Omega$	10	35	120	us
Turn-off delay time at $T_j = 25^\circ C$	$T_{d(off)}$		10	30	120	us
Turn-on voltage slope at $T_j = 25^\circ C$	$(dV_{OUT}/dt)_{on}$	$V_{CC}=13\text{ V}, V_{SEN}=5\text{ V}, R_L=4.3\Omega$	0.05	0.2	0.7	V/us
Turn-off voltage slope at $T_j = 25^\circ C$	$(dV_{OUT}/dt)_{off}$		0.1	0.4	0.7	
Differential pulse skew($t_{PHL} - t_{PLH}$)	t_{SKEW}	$V_{CC}=13\text{ V}, V_{SEN}=5\text{ V}, R_L=4.3\Omega$	-150	-	30	us

Logic input (IN0,1, SEL0, SEN)						
Parameter	Symbol	Test Condition	Min.	Typ.	Max.	Unit
Logic input low level voltage	V_L				0.9	V
Low level logic input current	I_L	$V_{INL}=0.9V$	0.5			μA
Logic input high level voltage	V_H		2.1		6.0	V
High level logic input current	I_H	$V_{INH}=2.1V$			12	μA
Logic input hysteresis voltage	$V_{(hyst)}$		0.1	0.3	0.7	V
Protections (7 V < V_{CC} < 18 V, -40 °C < T_j < 150 °C)						
Parameter	Symbol	Test Condition	Min.	Typ.	Max.	Unit
DC short circuit current	I_{LIMH}	$V_{CC}=13V, V_{SEN}=5V$	8	15	22	A
		$4.5V < V_{CC} < 18V, V_{SEN}=5V$			22	
Short circuit current during thermal cycling	I_{LIML}	$V_{CC}=13V, V_{SEN}=5V, T_R < T_j < T_{TSD}$		6		
Shutdown temperature	T_{TSD}		150	175	200	°C
Thermal hysteresis	T_{HYST}			20		°C
Dynamic temperature	ΔT_{J_SD}	$T_j = -40^\circ C, V_{CC}=13V$		60		°C
Current limit thermal hysteresis	T_R			40		°C
Turn-off output voltage clamp	V_{DEMAG}	$I_{OUT}=3A, V_{SEN}=5V, L=6mH, T_j = -40^\circ C$	$V_{CC}-33$			V
		$I_{OUT}=3A, V_{SEN}=5V, L=6mH, T_j = 25^\circ C \text{ to } 150^\circ C$	$V_{CC}-35$	$V_{CC}-38$	$V_{CC}-43$	
Current sense / 7 V < V_{CC} < 18 V, -40 °C < T_j < 150 °C						
Parameter	Symbol	Test Condition	Min.	Typ.	Max.	Unit
Current sense clamp voltage	V_{SENSE_CL}	$V_{SEN}=0V, I_{SENSE} = 1mA$		-15		V
		$V_{SEN}=0V, I_{SENSE} = -1mA$		7		
Current sense characteristics						
Parameter	Symbol	Test Condition	Min.	Typ.	Max.	Unit
I_{OUT}/I_{SENSE}	K_1	$I_{OUT}=0.5A, V_{SEN}=5V$	-40%	1550	+40%	
I_{OUT}/I_{SENSE}	K_2	$I_{OUT}=1A, V_{SEN}=5V$	-20%	1550	+20%	
I_{OUT}/I_{SENSE}	K_3	$I_{OUT}=2A, V_{SEN}=5V$	-12%	1550	+12%	
I_{OUT}/I_{SENSE}	K_4	$I_{OUT}=4A, V_{SEN}=5V$	-10%	1550	+10%	
Current sense leakage current	I_{SENSE0}	CS disabled: $V_{SEN}=0V$	0		0.5	μA
		CS disabled: $-1V < V_{SENSE} < 5V$	-0.5		3	
		CS enabled: $V_{SEN} = 5V$; All channels ON; $I_{OUTX} = 0A$; ChX diagnostic selected; <input type="checkbox"/> E.g. Ch0: $V_{IN0} = 5V; V_{IN1} = 5V; V_{SEL0} = 0V$; $I_{OUT0} = 0A; I_{OUT1} = 1A$	0		150	
		CS enabled: $V_{SEN} = 5V; I_{OUTX} = 0A$; ChX diagnostic selected; <input type="checkbox"/> E.g. Ch0: $V_{IN0} = 0V; V_{IN1} = 5V; V_{SEL0} = 0V$; $I_{OUT0} = 0A; I_{OUT1} = 1A$	0		2	

Output voltage for CS shut down	V_{OUT_MSD}	$V_{SEN}=5V, R_{SENSE}=2.7K, V_{IN0}=5V;$ $V_{SELO}=0V, I_{OUT0}=1A$		5		V
CS saturation voltage	V_{SENSE_SAT}	$V_{CC}=7V, R_{SENSE}=2.7K, V_{SEN}=5V, V_{IN0}=5V,$ $V_{SELO}=0V, I_{OUT0}=2A, T_J=150^\circ C$	5			V
CS saturation current	I_{SENSE_SAT}	$V_{CC}=7V, V_{SENSE}=4V, V_{IN0}=5V, V_{SEN}=5V,$ $V_{SELO}=0V, T_J=150^\circ C$	4			mA
Output saturation current	I_{OUT_SAT}	$V_{CC}=7V, V_{SENSE}=4V, V_{IN0}=5V, V_{SEN}=5V,$ $V_{SELO}=0V, T_J=150^\circ C$	6			A

OFF-state diagnostic

Parameter	Symbol	Test Condition	Min.	Typ.	Max.	Unit
OFF-state open load voltage detection threshold	V_{OL}	$V_{SEN}=5V, V_{IN}=0V, V_{SELO}=0V$	2	3	4	V
OFF-state output sink current	$I_{L(off2)}$	$V_{IN}=0V, V_{OUT}=V_{OL}, T_J=-40^\circ C \text{ to } 150^\circ C$	-450	-200	-80	μA
OFF-state diagnostic delay time from falling edge of INPUT	t_{DSTKON}	$V_{SEN}=5V, V_{IN0}=5V \text{ to } 0V, V_{SELO}=0V,$ $V_{OUT0}=4V, I_{OUT0}=0A$	100	350	700	μs
Settling time for valid OFF-state open load diagnostic indication from rising edge of SEN	$t_{D_OL_V}$	$V_{IN0}=0V, V_{SELO}=0V,$ $V_{OUT0}=4V, V_{SEN}=0V \text{ to } 5V$			150	μs
OFF-state diagnostic delay time from rising edge of V_{OUT}	t_{D_VOL}	$V_{SEN}=5V, V_{IN0}=0V, V_{SELO}=0V,$ $V_{OUT0}=0V \text{ to } 4V$		5	30	μs

Fault diagnostic feedback

Parameter	Symbol	Test Condition	Min.	Typ.	Max.	Unit
Current sense output voltage in fault condition	V_{SENSEH}	$V_{CC}=13V, R_{SENSE}=1K, V_{IN0}=0V,$ $V_{SEN}=5V, V_{SELO}=0V, I_{OUT0}=0A, V_{OUT0}=4V$	5.0	6.0	6.6	V
Current sense output current in fault condition	I_{SENSEH}	$V_{CC}=13V, V_{SENSE}=5V$	10	20	30	mA

Current sense timings

Parameter	Symbol	Test Condition	Min.	Typ.	Max.	Unit
Current sense settling time from rising edge of SEN	$t_{DSSENSE1H}$	$V_{IN}=5V, V_{SEN}=0V \text{ to } 5V,$ $R_{SENSE}=1K, R_L=13\Omega$			100	μs
Current sense disable delay time from falling edge of SEN	$t_{DSSENSE1L}$	$V_{IN}=5V, V_{SEN}=5V \text{ to } 0V,$ $R_{SENSE}=1K, R_L=13\Omega$		5	20	μs
Current sense settling time from rising edge of INPUT	$t_{DSSENSE2H}$	$V_{IN}=0V \text{ to } 5V, V_{SEN}=5V,$ $R_{SENSE}=1K, R_L=13\Omega$		80	250	μs
Current sense settling time from rising edge of I_{OUT} (dynamic response to a step change of I_{OUT})	$\Delta t_{DSSENSE2H}$	$V_{IN}=5V, V_{SEN}=5V, R_{SENSE}=1K,$ $I_{SENSE}=90\% \text{ of } I_{SENSEMAX}, R_L=13\Omega$			150	μs
Current sense turn-off delay time from falling edge of INPUT	$t_{DSSENSE2L}$	$V_{IN}=5V \text{ to } 0V, V_{SEN}=5V,$ $R_{SENSE}=1K, R_L=13\Omega$		80	250	μs
Current sense transition delay from Ch_X to Ch_Y	t_{D_XtoY}	$V_{IN0}=V_{IN1}=V_{SEN}=5V, V_{SELO}=0V \text{ to } 5V,$ $I_{OUT0}=0A, I_{OUT1}=1.5A, R_{SENSE}=1K$			60	μs
Current sense transition delay from stable current sense on Ch_X to V_{SENSEH} on Ch_Y	$t_{D_CS0toVSENSEH}$	$V_{IN0}=5V, V_{IN1}=0V, V_{SEN}=5V,$ $V_{SELO}=0V \text{ to } 5V, I_{OUT0}=1.5A,$ $V_{OUT1}=4V, R_{SENSE}=1K$			20	μs

Note6: Except for the special test instructions, all electrical parameters are tested under $T_A = +25^\circ C$. The minimum and maximum specification range of the specifications is guaranteed by the test, and the typical values are guaranteed by the design, test, or statistical analysis.

WSD7040AF Product Description

High-side driver with current sense analog feedback for automotive applications



Switching Status and Timing Relationship

Switching time and pulse skew

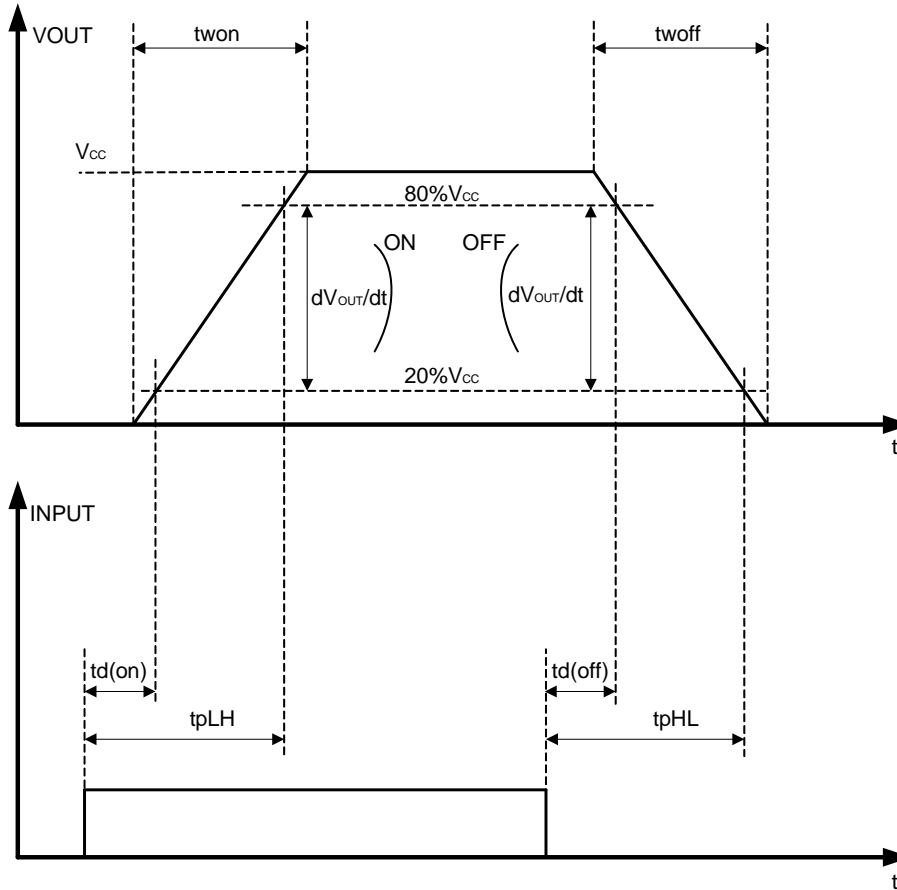

Current sense timings (current sense mode)

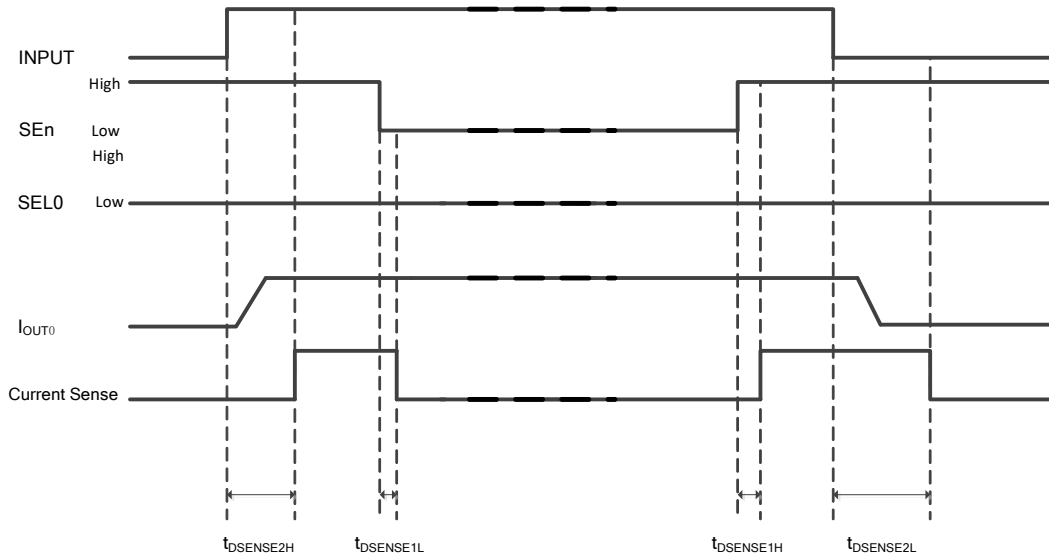

T_{DSTKON}

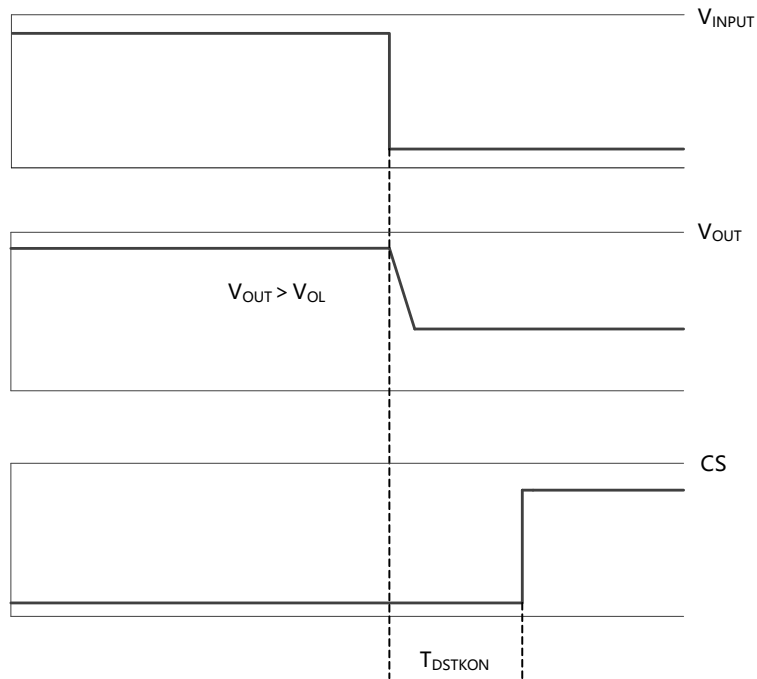

Table 2. Truth table

Mode	Conditions	IN _x	SEn	SEL0	OUT _x	Current sense	Comments
Standby	All logic INs low	L	L	L	L	Hi-Z	Low quiescent current consumption
Normal	Nominal load connected; T _j < 150°C	L	See Table 3		L	See Table 3	
		H			H	See Table 3	
Overload	Overload or short to GND causing: T _j > T _{TSD} or ΔT _j > ΔT _{j_SD}	L	See Table 3		L	See Table 3	
		H			L	See Table 3	Output cycles with temperature hysteresis
Undervoltage	V _{CC} < V _{USD}	X	X		L	Hi-Z	Re-start when V _{CC} > V _{USD} + V _{USDhyst} (rising)
OFF-state diagnostics	Short to V _{CC}	L	See Table 3		H	See Table 3	
	Open-Load	L			H	See Table 3	External pull-up
Negative output voltage	Inductive loads turn-off	L	See Table 3		< 0	See Table 3	

Table 3. Current sense output

SEn	SEL0	MUX Channel	Current sense output			
			Normal	Overload	OFF-state	Negative output
L	X		Hi-Z			
H	L	Channel 0 diagnostic	I _{SENSE} = I _{OUT0} /K	V _{SENSE} = V _{SENSEH}	V _{SENSE} = V _{SENSEH}	Hi-Z
H	H	Channel 1 diagnostic	I _{SENSE} = I _{OUT1} /K	V _{SENSE} = V _{SENSEH}	V _{SENSE} = V _{SENSEH}	Hi-Z

Electrical Characteristics Curves

OFF-state output current

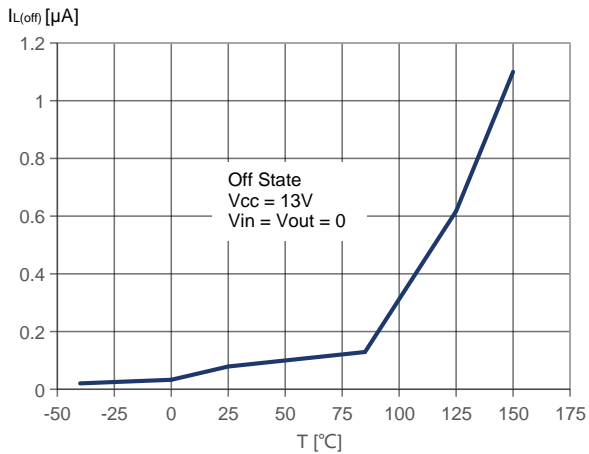

Standby current

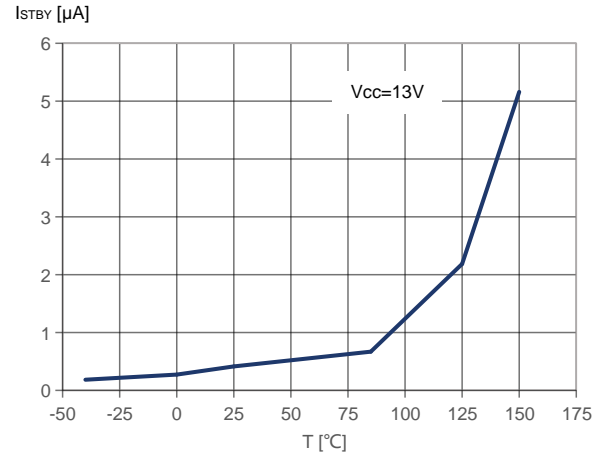

I_GND(ON) vs. T_A

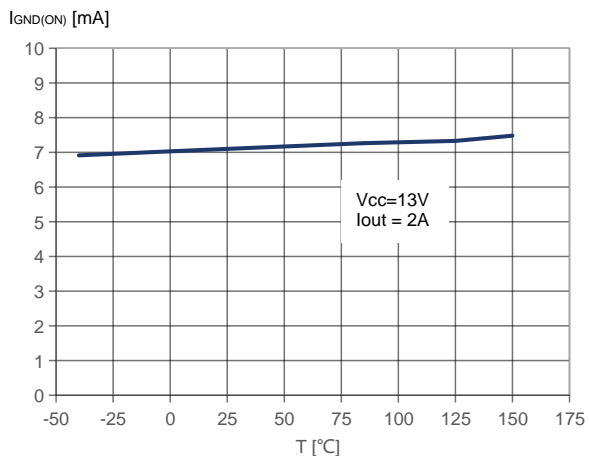

Logic Input high level voltage

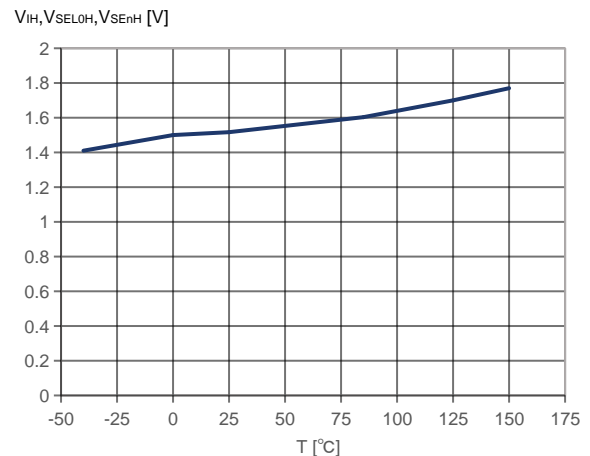

Logic Input low level voltage

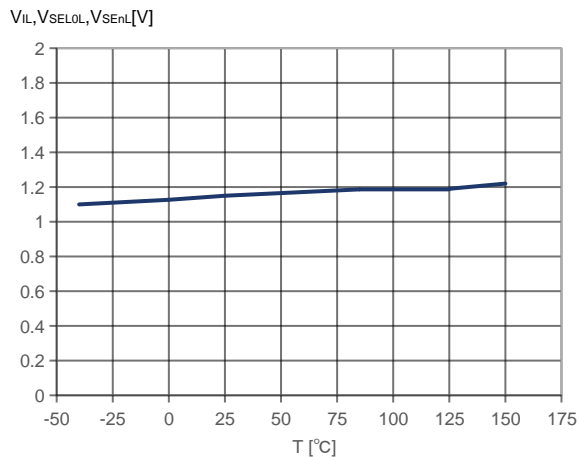

High level logic input current

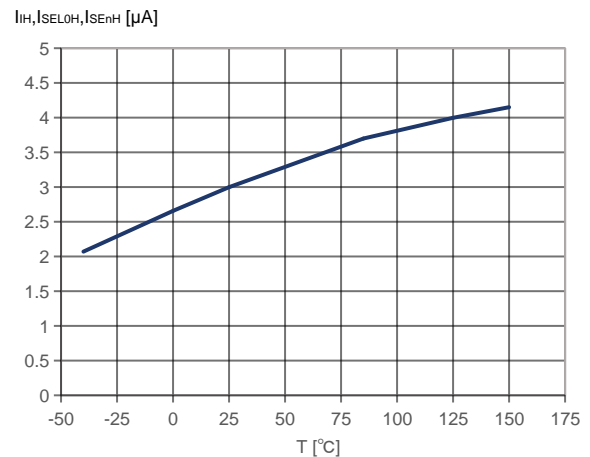

Low level logic input current

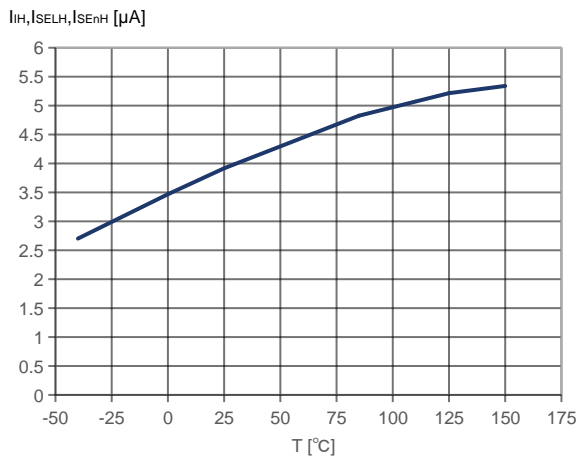

Logic Input hysteresis voltage

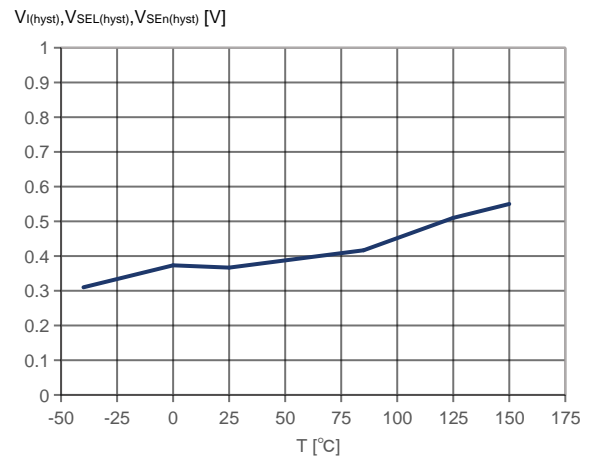

Undervoltage shutdown

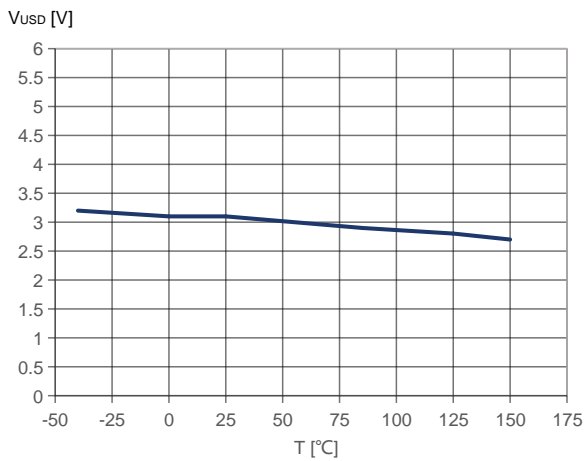

On-state resistance vs. TA

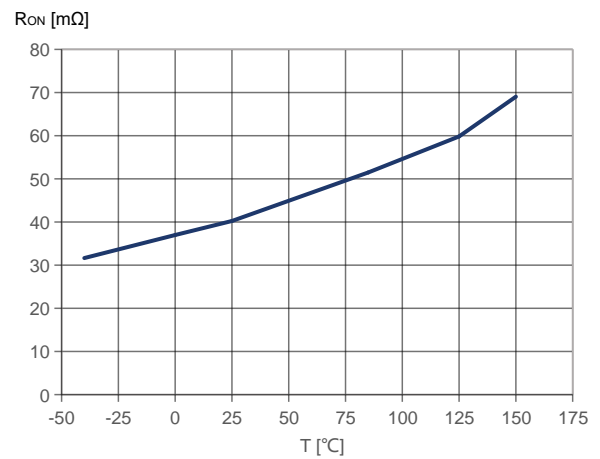

On-state resistance vs. TA

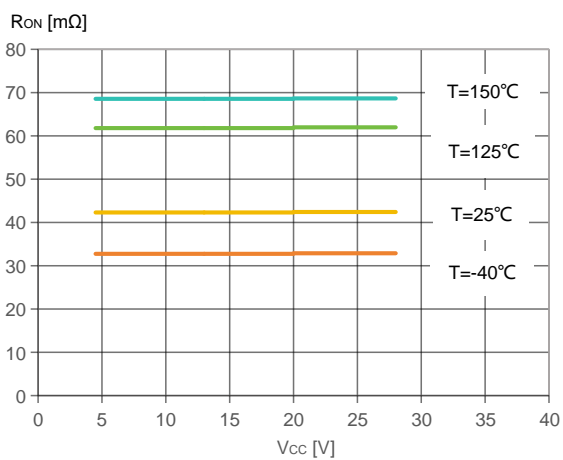

Turn-on voltage slope

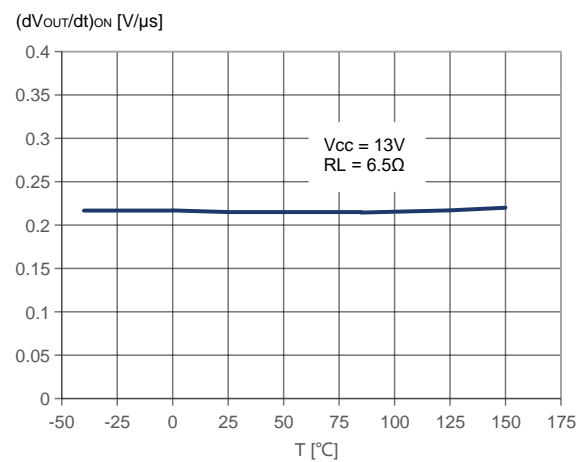

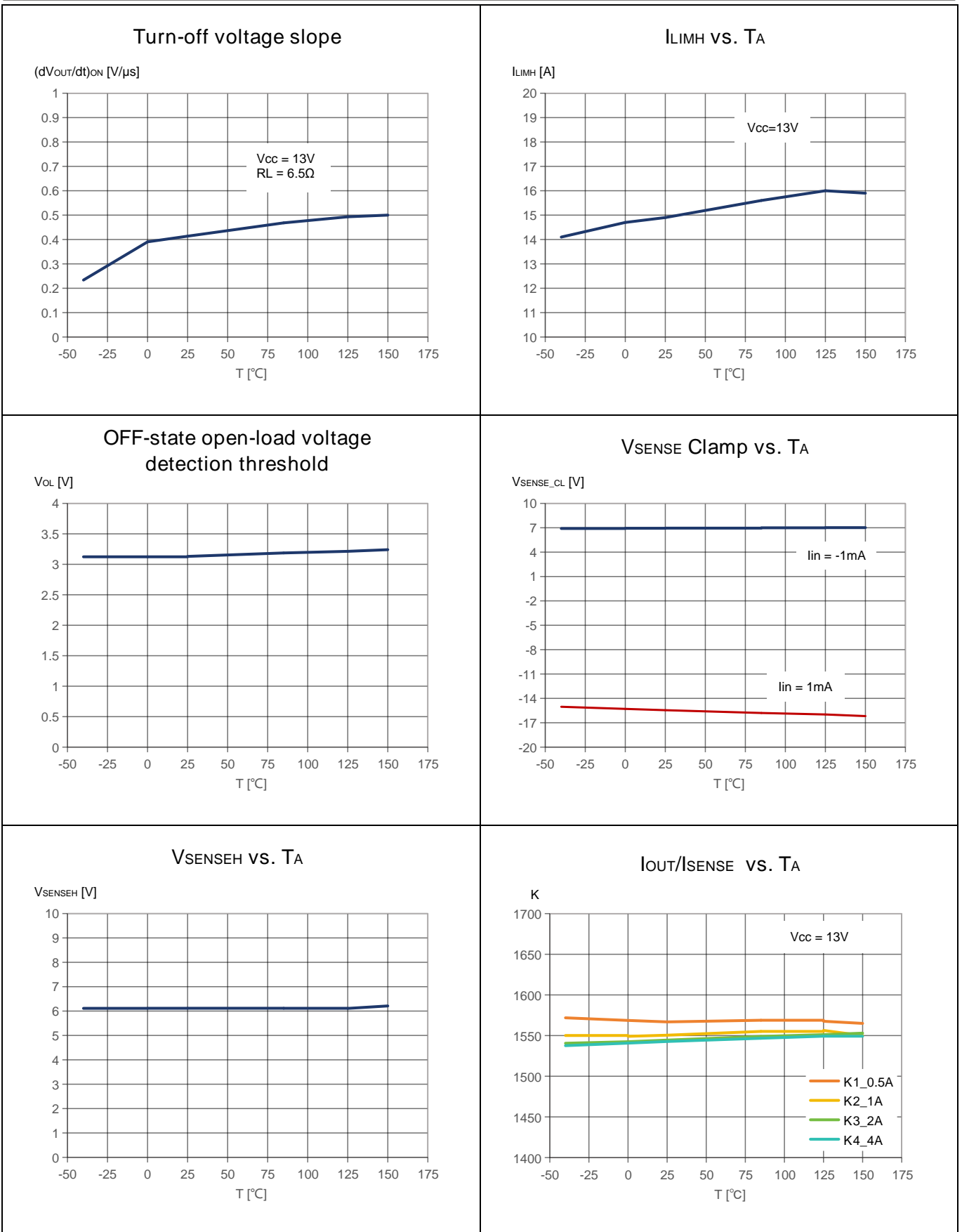

Functional Description

Power limitation

The basic working principle of this protection consists of an indirect measurement of the junction temperature swing ΔT_j through the direct measurement of the spatial temperature gradient on the device surface in order to automatically shut off the output MOSFET as soon as ΔT_j exceeds the safety level of ΔT_{j_SD} . The protection prevents fast thermal transient effects and, consequently, reduces thermo-mechanical fatigue.

Thermal shutdown

In case the junction temperature of the device exceeds the maximum allowed threshold (typically 175°C), it automatically switches off and the diagnostic indication is triggered.

Current limitation

The device is equipped with an output current limiter in order to protect the silicon as well as the other components of the system (e.g. bonding wires, wiring harness, connectors, loads, etc.) from excessive current flow. Consequently, in case of short circuit, overload or during load power-up, the output current is clamped to a safety level, I_{LIMH} , by operating the output power MOSFET in the active region.

Negative voltage clamp

In case the device drives inductive load, the output voltage reaches a negative value during turn off. A negative voltage clamp structure limits the maximum negative voltage to a certain value, V_{DEMAG} , allowing the inductor energy to be dissipated without damaging the device.

Diode (D_{GND}) in the ground line

A resistor (typ. $R_{GND}=4.7K$) should be inserted in parallel to D_{GND} if the device drives an inductive load. This small signal diode can be safely shared amongst several different HSDs. Also in this case, the presence of the ground network produces a shift ($\approx 600mV$) in the input threshold and in the status output values if the microprocessor ground is not common to the device ground. This shift does not vary if more than one HSD shares the same diode/resistor network.

MCU I/Os protection

If a ground protection network is used and negative transients are present on the V_{CC} line, the control pins will be pulled negative. WS suggests to insert a resistor ($R_{prot}=15K$) in line both to prevent the micro-controller I/O pins from latching-up and to protect the HSD inputs. The value of these resistors is a compromise between the leakage current of micro-controller and the current required by the HSD I/Os (Input levels compatibility) with the latch-up limit of micro-controller I/Os.

CS - analog current sense

Diagnostic information on device and load status are provided by an analog output pin (CS) delivering the following signal:

- Current monitor: current mirror of channel output current

The signal are routed through an analog multiplexer which is configured and controlled by means of SEL0 and SEn pins, according to the address map in CS multiplexer addressing Table.

Current monitor

When current mode is selected in the CS, this output is capable to provide:

- Current mirror proportional to the load current in normal operation, delivering current proportional to the load according to known ratio named K
- Diagnostics flag in fault conditions delivering fixed voltage V_{SENSEH}

The current delivered by the current sense circuit, I_{SENSE} can be easily converted to a voltage V_{SENSE} by using an external sense resistor, R_{SENSE} , allowing continuous load monitoring and abnormal condition detection.

While device is operating in normal conditions (no fault intervention), V_{SENSE} calculation can be done using simple equations.

Current provided by CS output: $I_{SENSE} = I_{OUT}/K$

Voltage on R_{SENSE} : $V_{SENSE} = R_{SENSE} * I_{SENSE} = R_{SENSE} * I_{OUT}/K$

Where:

- V_{SENSE} is voltage measurable on R_{SENSE} resistor
- I_{SENSE} is current provided from CS pin in current output mode

Package Outline

DFN5×6-14L

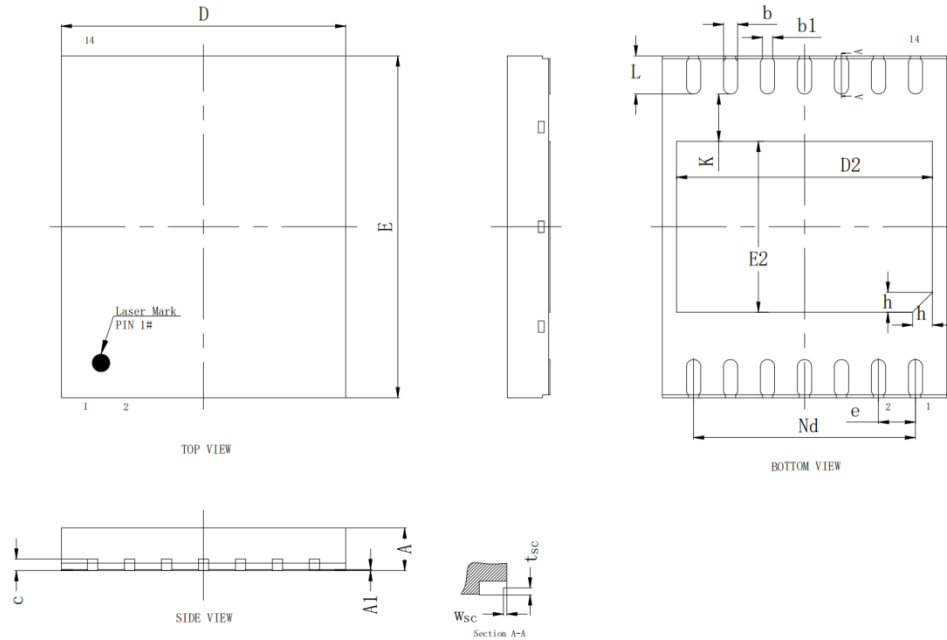

SYMBOL	MILLIMETER		
	MIN	NOM	MAX
A	0.70	0.75	0.80
A1	0	0.02	0.05
b	0.20	0.25	0.30
b1	0.18REF		
c	0.203REF		
D	4.90	5.00	5.10
D2	4.40	4.50	4.60
e	0.65BSC		
Nd	3.90BSC		
E	5.90	6.00	6.10
E2	2.90	3.00	3.10
L	0.62	0.67	0.72
h	0.30	0.35	0.40
K	0.83REF		
W _{sc}	0.01	-	0.09
t _{sc}	0.08	-	0.18

Tape and Reel Information

DFN5x6-14L Carrier tape

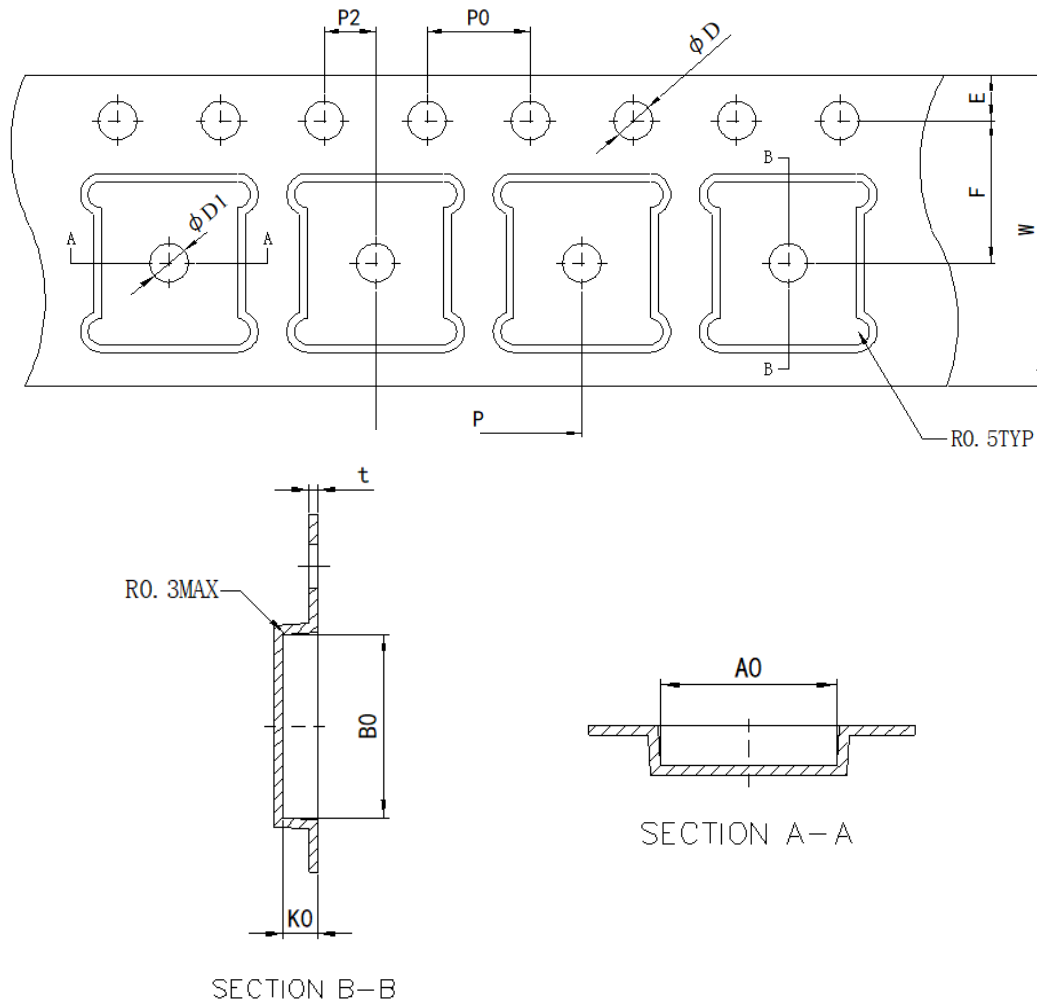

DFN5x6-14L Carrier Tape Dimensions

Description	Value (Unit: mm)
E	1.75±0.10
F	5.50±0.05
P2	2.00±0.05
D	1.50±0.1
D1	1.50 MIN
P0	4.00±0.10
W	12.00±0.1
P	8.00±0.10
A0	5.30±0.10
B0	6.30±0.10
K0	1.20±0.10

DFN5x6-14L Reel (13 ")

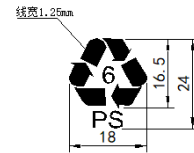
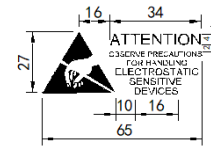
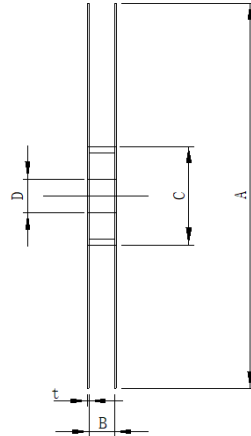
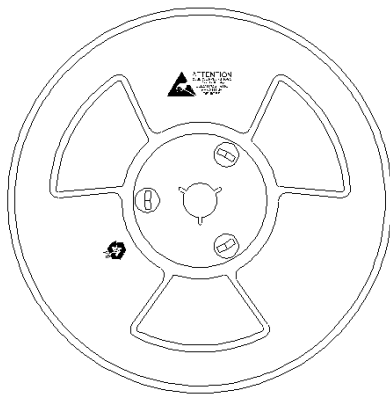

DFN5x6-14L Reel Dimensions

Description	Value (Unit: mm)
Carrier width	12
A	329±1
B	12.4+2
C	100±1
D	13.3±0.3
t	2.0±0.3

Tape and Reel Information

Package	Reel	QTY/Reel	Reel/Inner Box	Inner Box/Carton	QTY/Carton	Inner Box Size (mm)	Carton Size (mm)
DFN5x6-14L	13 "	3000	1	8	24000	336x336x48	420x355x365

CONTACT

Winsemi Microelectronics Co., Ltd.

ADD: Room 3101-3102, 31F, Building 8A, Shenzhen International Innovation Valley, Nanshan District, Shenzhen, P.R. China.

Post Code : 518040

Tel : 86-0755-82506288

Fax: 86-0755-82506299

Website : www.winsemi.com